

Article number: 20478B10M6MT

Description: E+G Clamp mounting - GN 478-B10-M6-MT

Measures

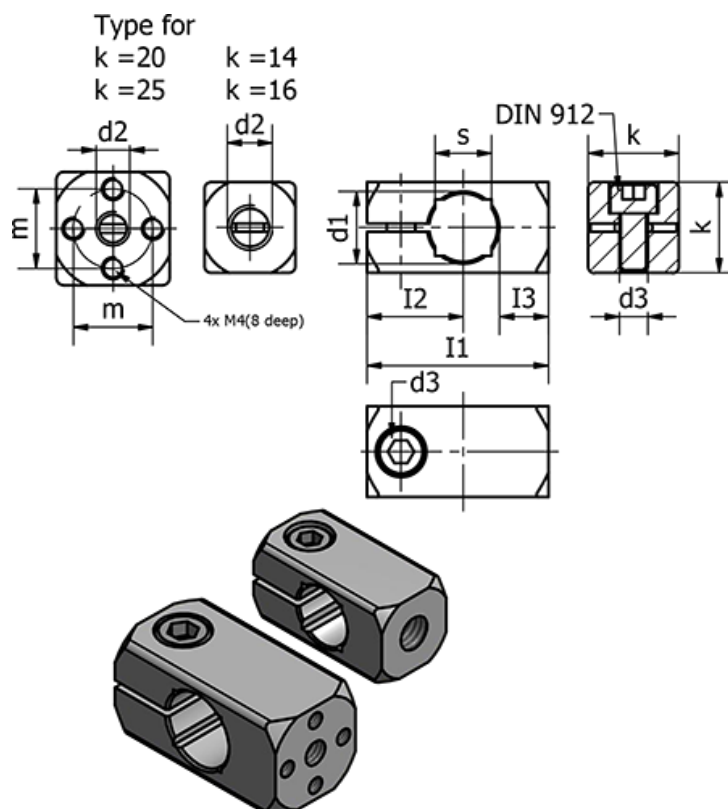

Clamping kit for d2 = GN 511-M5-16

d1 h11 = 10
 d2 = M6
 d3 = M5
 I1 = 30
 I2 = 17
 I3 = 8
 k = 16

m =
 s = 8
 Weight (g) = 20